

# WIATA ŚMIETNIKOWA W-SMB 9280x 1700 mm

widok z przodu

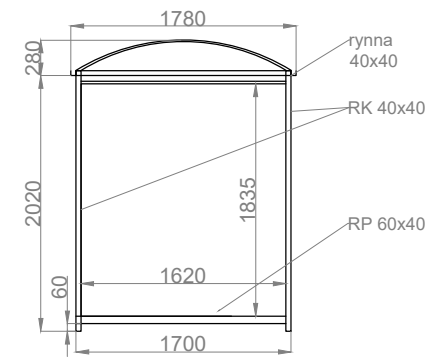

rzut przyziemia

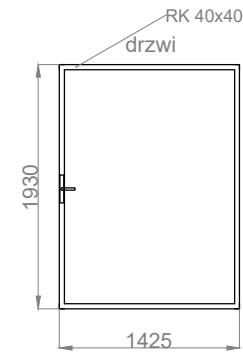
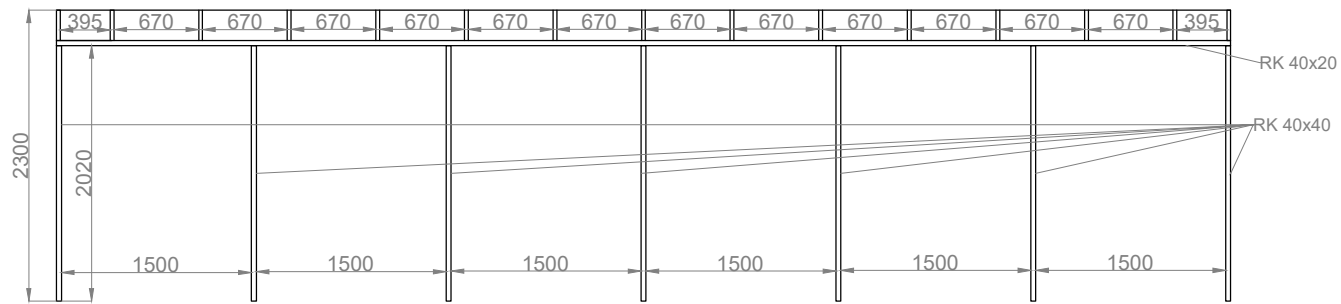
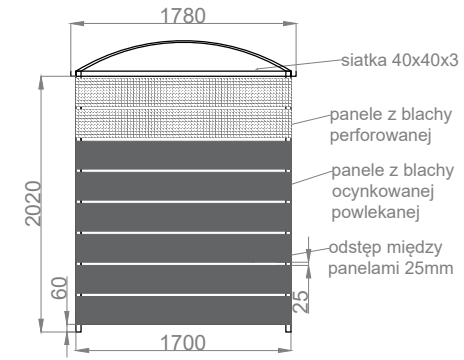
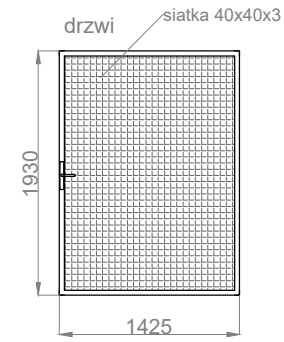
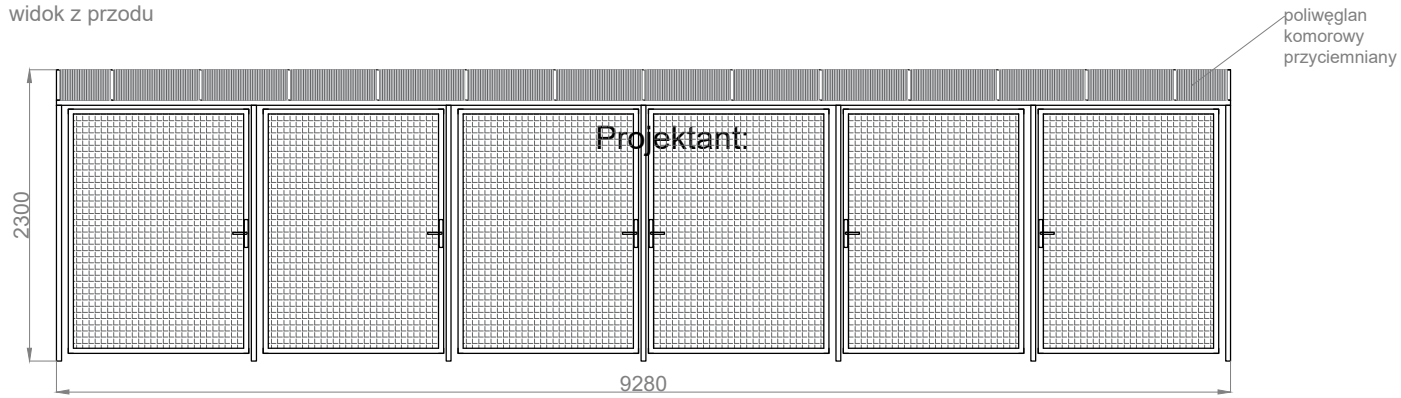
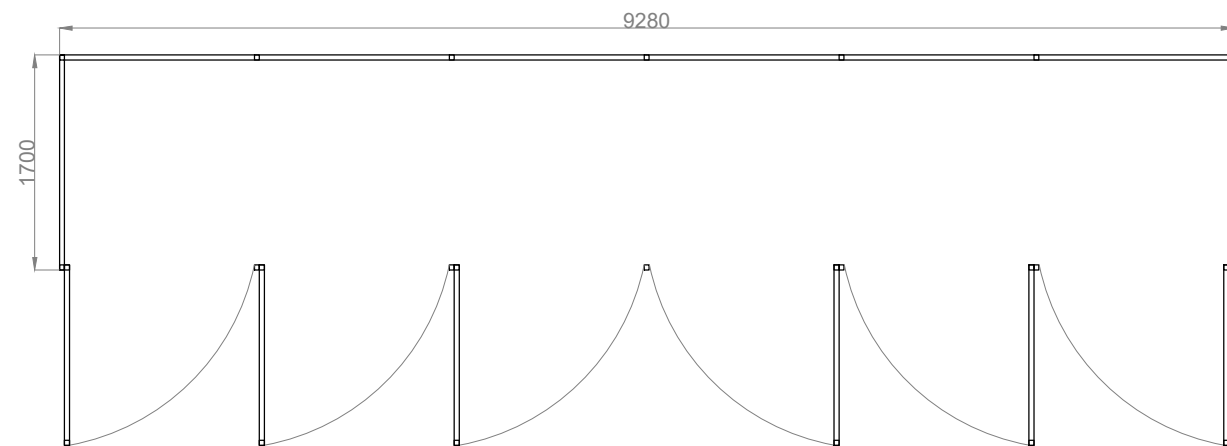

rzut dachu

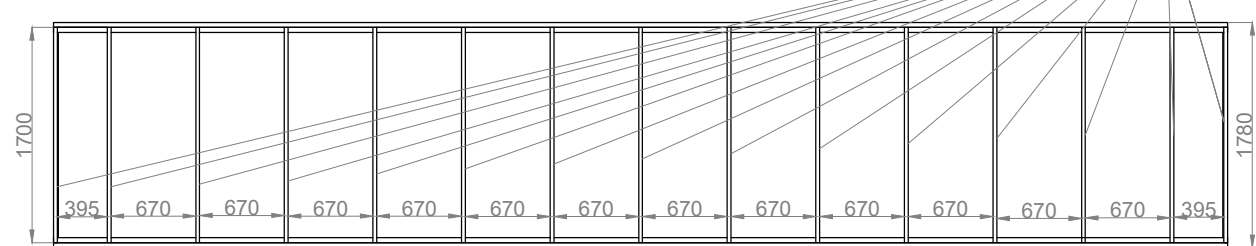

Nazwa: W-SMB	Nr rysunku:	SPECYFIKACJA : - konstrukcja stalowa, - malowana na kolor RAL - dach pokryty poliwęglanem komorowym - ściany pokryte panelami - górna część ścian wypełniona panelami z blachy perforowanej - drzwi jednoskrzydłowe wypełniona siatką 40x40x3
Producent: FIRMA KROLL BERNADETA MAZUR ul. Jana Pawła II 50, 89-200 Szubin NIP: 558 115 28 36		
Projektant:		